

# anchor

surgical needles  
and other OR related products

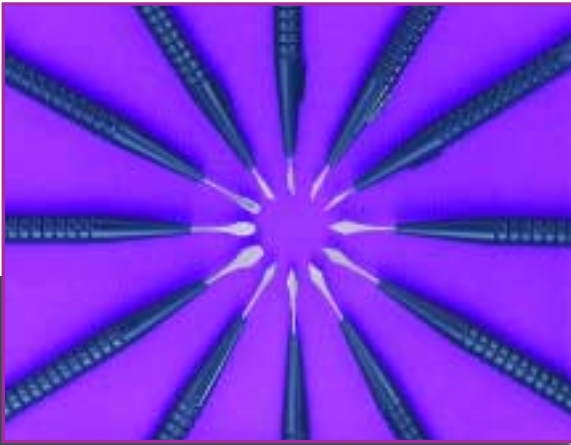



Anchor's goal, as it has been since 1925, is to manufacture the finest surgical products. We have expanded our line from the days of suture needles only, in the 1970's, to include Laparoscopic, Ophthalmic, Biopsy, and Veterinary devices. As we approach the new millennium Anchor will continue to strive to meet the ever growing needs of surgeons worldwide.

All products are available on an OEM basis, please contact Anchor for more information.



<b>SOFT TISSUE BIOPSY DEVICES</b>		4
<b>OPHTHALMIC BLADES</b>		5
<b>SHARPS COUNT SYSTEMS</b>		6
Count-Tainer® 20 (foam)	5120F	
Count-Tainer® 20 (magnetic)	5220M	
Count-Tainer® 40 (foam)	5100F	
Count-Tainer® 40 (magnetic)	5200M	
Count-Tainer® 50 (foam block)	5350	
<b>OTHER O.R. PRODUCTS</b>		7
Trocar Port Suture Needle	TR-1001	
Myringotomy Blade (with handle)	MB-3003	
Reusable stainless sterilizing rack		
Reusable stainless sterilizing box		
<b>NEEDLE PACKAGING</b>		7
<b>CUSTOM NEEDLE KITS</b>		8
<b>SURGICAL NEEDLES</b>	<b>Style No.</b>	<b>Page</b>
Abscission	1851	9
Bunnels	1854	9
Cervix	1835	9
Dura	(see 1833 and 1842)	9
Eye	1830, 1831, 1833	
	1857	9
Ferguson	1842	9
Fish Hook	1853	10
Fistula	1832	10
French Spring Eye	1861, 1862	10
Hagedorn	1852	10
Hernia	1829, 1847	10
Intestinal	1843,1850	10
Keith	1827	11
Kidney	1838, 1839, 1840	11
King	1841	11
Lanes, Cleft Palate	1844, 1848	11
Loopuyt's	1846	11
Martin Uterine	1860	12
Mayo	1824	12
Mayo Intestinal	1823, 1828, 1837	12
McGowan	1859	12
Murphy Intestinal	1825	12
Orthopedic	1869, 1870	12
Regular Surgeons	1821	13
	1822, 1834,	13
Tonsil, Davis	1845,1849	13
Trocar	1826,1836	13
<b>DENTAL NEEDLES</b>		14
<b>POST MORTEM &amp; VETERINARY NEEDLES</b>		15 and 16
<b>NEEDLE CONVERSION CHART: Sterile Disposable</b>		17
<b>NEEDLE CONVERSION CHART: Non-Sterile Reusable</b>		18
<b>VETERINARY SUTURE CASSETTES</b>		19



## ONE HAND OPERATION

- innovative, comfort-designed, pistol-grip handle fits any hand
- permits excellent control during soft tissue biopsy procedures
- automatic locking assures secure, consistent, accurate sample removal
- sharp cutting needle of polished stainless steel for smooth penetration
- single-use, disposable, sterile device, with several gauges and lengths to choose from
- economical, competitively priced, American made

### ORDERING INFORMATION:

SPECIFY CODE NO.

Code No.	Gauge	Notch	Length	
ABD6-14	14	19mm	6"	15.2cm
ABD45-14	14	19mm	4½"	11.4cm
ABD6-18	18	19mm	6"	15.2cm
ABD45-18	18	19mm	4½"	11.4cm
ABD6-20	20	19mm	6"	15.2cm
ABD3-20	20	19mm	3"	7.6cm
ABD15-14*	14	19mm	15"	38.1cm
ABD15-18*	18	19mm	15"	38.1cm
ABD45-14S	14	9.5mm	4½"	11.4cm
ABD3-20S	20	9.5mm	3"	7.6cm

EACH DEVICE PACKAGED STERILE/DISPOSABLE  
AVAILABLE IN BOXES OF 5 UNITS OR CASES OF 20 UNITS

\*Available in single unit cartons only

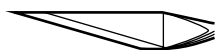

**AB101**



**AB102**

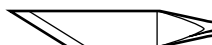

**AB103**

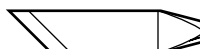

**AB104**



**AB200 Series**



**AB300 Series**

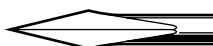

**AB401**



**AB500 Series**

PRODUCT CODE	DESCRIPTION	PACKAGING
--------------	-------------	-----------

### Stab Incision Eye Knives

AB101	Blade Length 5.7mm, Blade Angle 15°	6 per box
AB102	Blade Length 5.7mm, Blade Angle 22.5°	6 per box
AB103	Blade Length 5.7mm, Blade Angle 30°	6 per box
AB104	Blade Length 5.7mm, Blade Angle 45°	6 per box

### Phaco/Slit Knives

AB201S	Blade Width 2.5mm, Straight	6 per box
AB201A	Blade Width 2.5mm, Angled	6 per box
AB202S	Blade Width 2.8mm, Straight	6 per box
AB202A	Blade Width 2.8mm, Angled	6 per box
AB203S	Blade Width 3.0mm, Straight	6 per box
AB203A	Blade Width 3.0mm, Angled	6 per box
AB204S	Blade Width 3.2mm, Straight	6 per box
AB204A	Blade Width 3.2mm, Angled	6 per box
AB205S	Blade Width 3.5mm, Straight	6 per box
AB205A	Blade Width 3.5mm, Angled	6 per box

### IOL Round Tip Implant Knives

AB301S	Blade Width 4.0mm, Straight	6 per box
AB301A	Blade Width 4.0mm, Angled	6 per box
AB302S	Blade Width 5.2mm, Straight	6 per box
AB302A	Blade Width 5.2mm, Angled	6 per box

### MVR Corneal/Scleral Blade

AB401	20 Gauge	6 per box
-------	----------	-----------

### Crescent Knives

AB501S	Straight	6 per box
AB501A	Angled	6 per box

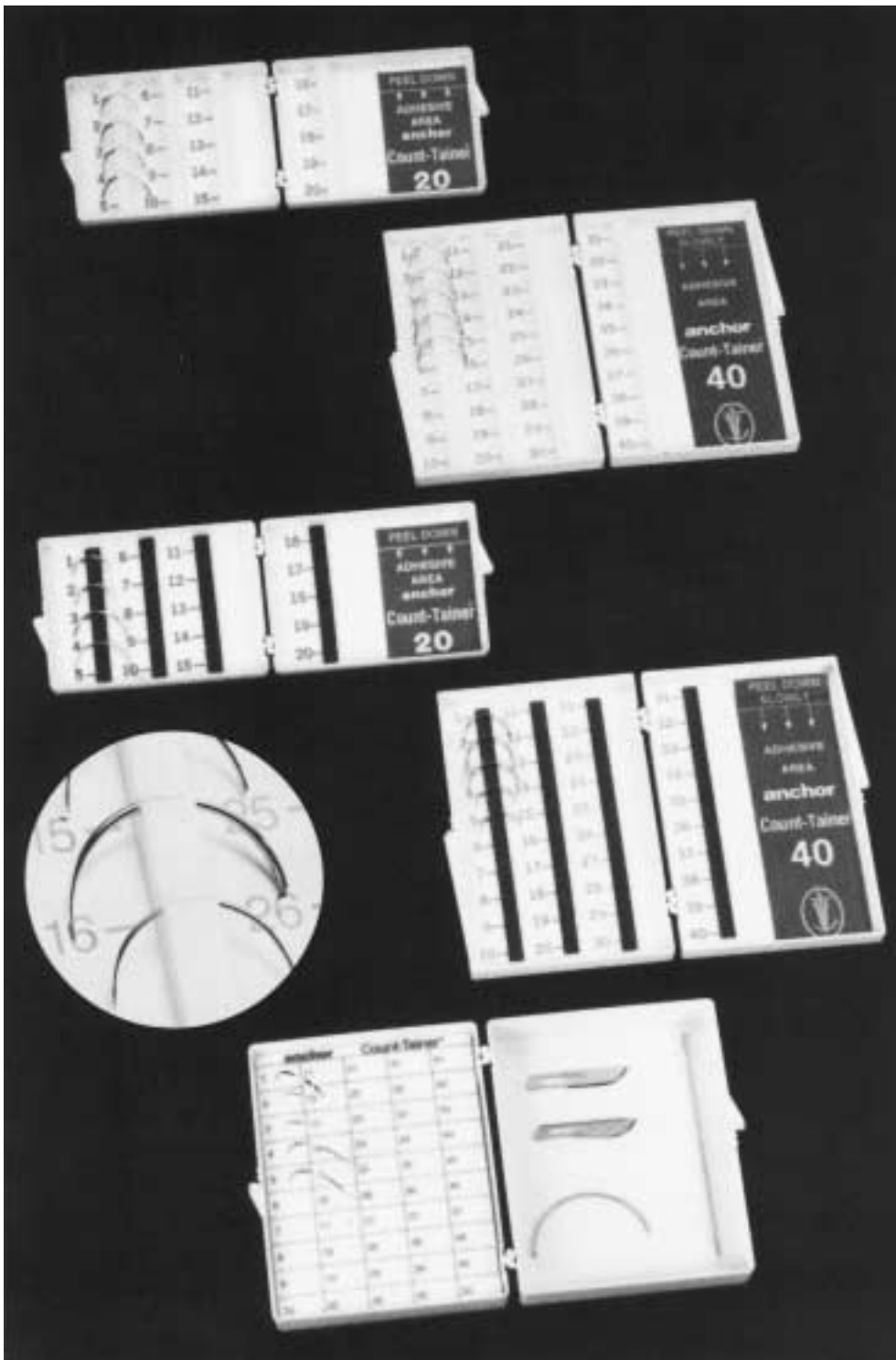

## IMPROVED COUNT-TAINER®, INJECTION MOLDED IN TOUGH IMPACT PLASTIC

### Count-Tainer® 20

Developed for minor procedures, as a compact version of the widely accepted Count-Tainer® 40, complete with friction-fit slotted foam.\*

Friction-fit slotted foam provides for a more rapid technique—saves time by just popping the needle in place in an ordered format—no need to reclamp needles.

Non-flaking foam strips minimize particulate matter.

Large, legible numerals for ease in counting.

Backing tape secures to any surface—a “no hands on product” procedure.

Rigid plastic construction with positive lock eliminates needle punctures and escaping sharps.

Adhesive well for larger needles, blades, and miscellaneous sharps.

Available in both a slotted foam version (Code number 5120F) and a magnetic version (Code number 5220M). Both versions are pouched sterile, disposable—20 units to a dispenser, 80 units to a case (4 dispensers).

### Count-Tainer® 40

This widely accepted sharps count system is intended for use in major procedures. Count-Tainer® 40 has the identical features and benefits described above in the Count-Tainer® 20.

Available in both a slotted foam version (Code number 5100F), and a magnetic version (Code number 5200M). Both versions are pouched sterile, disposable—10 units to a dispenser, 40 units to a case (4 dispensers).

### Count-Tainer® 50

Large foam block design for major procedures. Foam block ensures secure placement, with room for 50-100 needles. Adhesive well for larger needles, blades and miscellaneous sharps. Pouched sterile, disposable—64 units to a case. CODE NUMBER 5350.

\* Patent No. 4243140

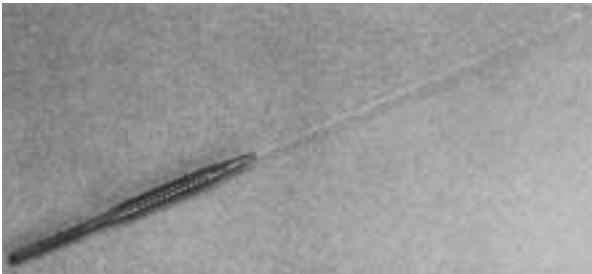

### TROCAR PORT SUTURE NEEDLE

NEW, from ANCHOR, a TROCAR PORT SUTURE NEEDLE for use in laparoscopic surgery. A Simple, Effective and Economical way to reduce Trocar Port Hernias. It has a cutting edge point for penetrating fascia and an ergonomic handle for superior control.

Each box contains one needle in a sterile pouch.

Product Code #TR-1001

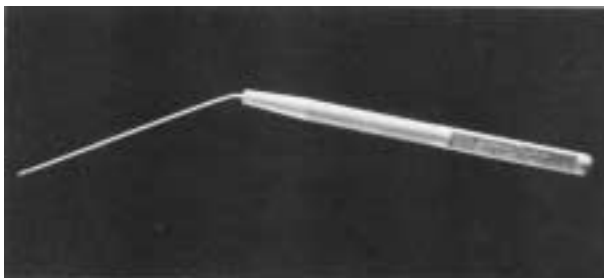

### MYRINGOTOMY "DOUBLE EDGE" BLADE

Sterile Disposable MYRINGOTOMY BLADE, with a 30 degree bend, for use in E.N.T. surgery. The blade is manufactured from quality stainless steel, 20 gauge diameter, which is ground, honed and 100% inspected to ensure that the edge meets our high performance standards.

Each box contains 20 sterile single packed blades.

Sterile with handle (length: 7") Product Code #MB-3003

### NEEDLE STERILIZING RACK

Reusable stainless steel rack with spring holder, firmly aligns up to 24 surgical eyed needles during sterilization.

Available in three models: the Narrow Spring Holder, #1700, for smaller needles; the Straight Spring Holder, #1800, for large gauge needles; and the Tapered Spring Holder, #1900, for a variety of small and large needles.

### NEEDLE STERILIZING BOX

Reusable two-piece stainless steel container designed to accommodate the Needle Sterilizing Rack and other miscellaneous stainless steel products during sterilization.

Sterilizing Box 4" x 5" x 1/2"	No. 1798
Narrow Spring Holder	No. 1700
Straight Spring Holder	No. 1800
Tapered Spring Holder	No. 1900

Combinations of Boxes, Holders and Needles:

Box with No. 1700 Holder	No. 1798-17
Box with No. 1800 Holder	No. 1798-18
Box with No. 1900 Holder	No. 1798-19

Note: The above spring holders are available with 2 dozen needles — simply add on an A after code number. (Example: 1700A)

### NEEDLE PACKAGING

Anchor *Disposable* Needles are packed in units of two. Each pair of needles is double-pouched in "see-through," peel-apart, sterile Tyvek®.

They are available in small cartons of 40 needles (20 pouches), and a dispenser-pack gross of 144 needles (72 pouches). Order by the needle number and add the suffix "DC" for disposable cartons, example: 1824-4DC. Add the suffix "DG" for disposable gross boxes, example: 1824-4DG.

Anchor *Reusable* Needles are non-sterile and are packed in units of six (minimum order: 2 packages, 1 dozen). Each unit is contained in the widely known Anchor purple glassine envelope and sleeve that clearly identifies the quantity, style and size. Order by the needle number and add the suffix "R" for reusable, example: 1824-4R.





## PROPER NEEDLE USE

Improper surgical technique in the use of a suturing needle may result in needle breakage. Small needle holders should be used on fine gauge needles and heavy holders on heavy gauge needles to avoid needle breakage because of undue stress. The weakest part of a needle is the eye and the point. Anchor needles are manufactured with a flat area on the shank to facilitate proper clamping with holder and to prevent turning in holder. The needle holder should be applied on the needle flat part about 1/4 of length of needle from the eyed end. **DO NOT CLAMP HOLDER DIRECTLY ON THE EYE, OTHERWISE BREAKAGE MAY OCCUR.** When withdrawing needle, clamp needle on shank about 1/4 length from the point. **DO NOT GRASP NEEDLE POINT, OTHERWISE BREAKAGE MAY OCCUR.** "Examine needle carefully after each use. If needle becomes bent or damaged during use, withdraw and discard needle. **DO NOT RE-USE BENT OR DAMAGED NEEDLE, OTHERWISE BREAKAGE MAY OCCUR.**"



## ANCHOR-PAK...the time saver; the money saver.

The ultimate in eyed-needle organization. Take the time now to set up *only once*, your needle requirements for any given surgical procedure. Send the set-up to ANCHOR and we will duplicate the set-up in a kit format. Each individual needle will be aligned in a unique friction-fit slot on a foam strip. Since there is no needle penetration of the foam, the risk of particulate matter is minimized. Simply lift out as needed.

ANCHOR will also custom imprint the kit by hospital name, procedure, and number of needles. Each kit is double-pouched in Tyvek®, sterilized, and shipped—organized and ready for use.

It's as good as it sounds. So, take the time now to do your set-up, and send it to Anchor.

We have a feeling it may be *your last set-up*.

Ask about our Sample Kit Program.

# SURGICAL NEEDLES



Needles are available both sterile (disposable) and non-sterile (reusable) unless otherwise indicated.

**Anchor Disposables:** Order by needle number and add the suffix "DC" for disposable cartons of 40 needles (20 pouches), example 1824-4DC. Add the suffix "DG" for disposable gross boxes of 144 needles (72 pouches), example: 1824-4DG.

**Anchor Reusables:** Order by needle number and add the suffix "R" for reusable, example: 1824-4R.

All needles are shown full scale in this catalog. For your convenience a cross-reference guide is included to show styles and sizes equivalent to other brands of surgical needles.

## ABSCISSION $\frac{3}{8}$ circle

1851

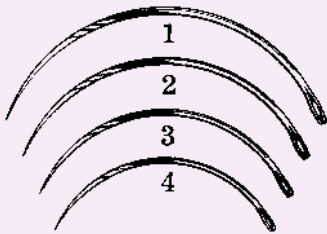

## BUNNELS straight

1854

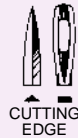
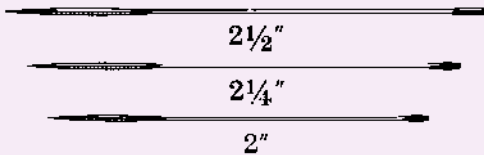

## CERVIX $\frac{3}{8}$ circle

1835

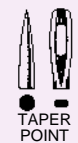
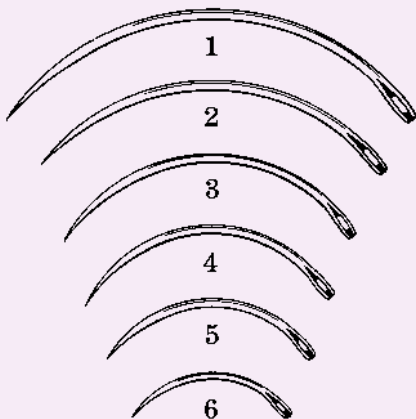

## EYE

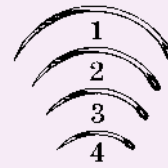

$\frac{3}{8}$  circle  
1830

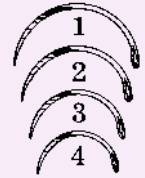

$\frac{1}{2}$  circle  
1831



$\frac{1}{2}$  circle  
1833



(1833-3, 1833-4 also used for dura)



Jameson Strabismus  
1857

(non-sterile only)



## FERGUSON $\frac{1}{2}$ circle

1842

(1842-20, 1842-22 also used for dura)

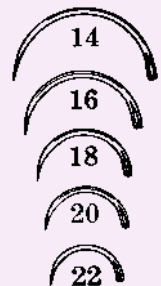
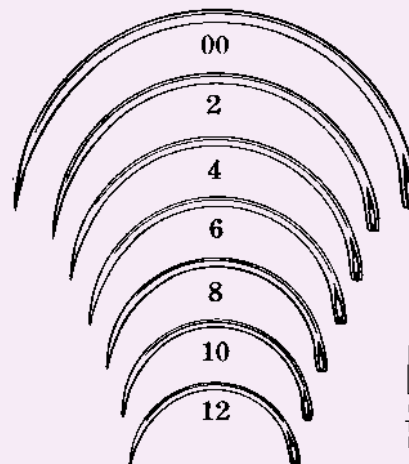

# SURGICAL NEEDLES

## FISH HOOK

1853-3

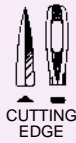

## HERNIA

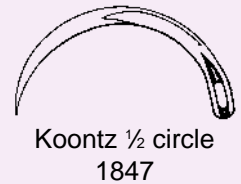
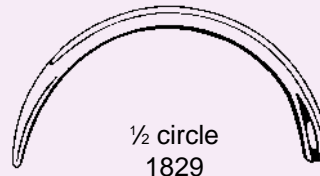

(1824-6, 1849 also used for hernia)

## FISTULA 1/2 circle (heavy gauge)

1832

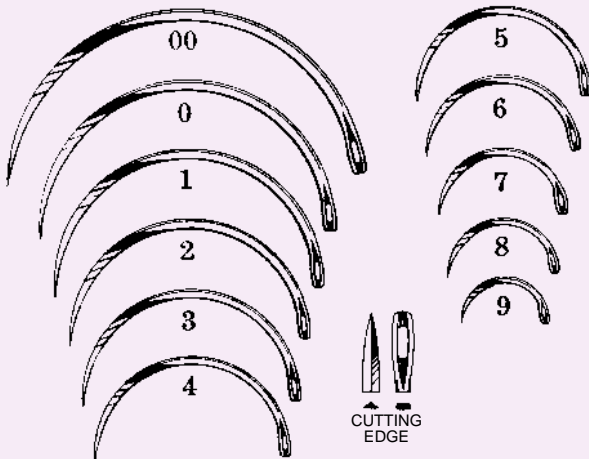

## INTESTINAL straight (fine)

1843

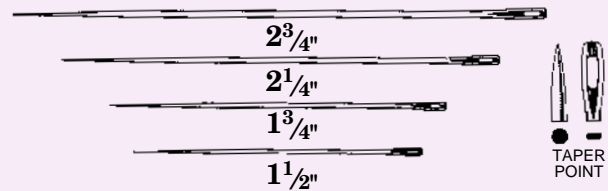

## FRENCH SPRING EYE 1/2 circle

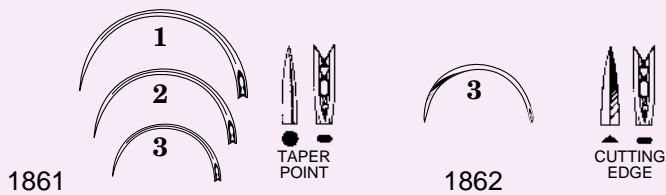

## INTESTINAL 1/2 circle (fine)

1850

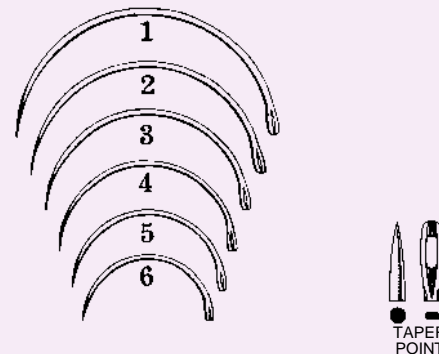

## HAGEDORN straight (flat body)

1852  
(non-sterile only)

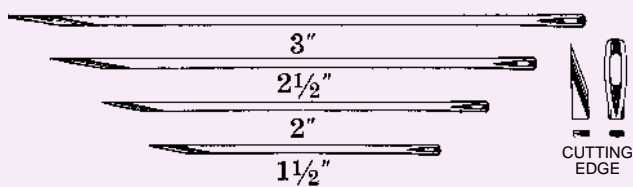

All needles are shown full scale in this catalog.

**KEITH straight**

1827

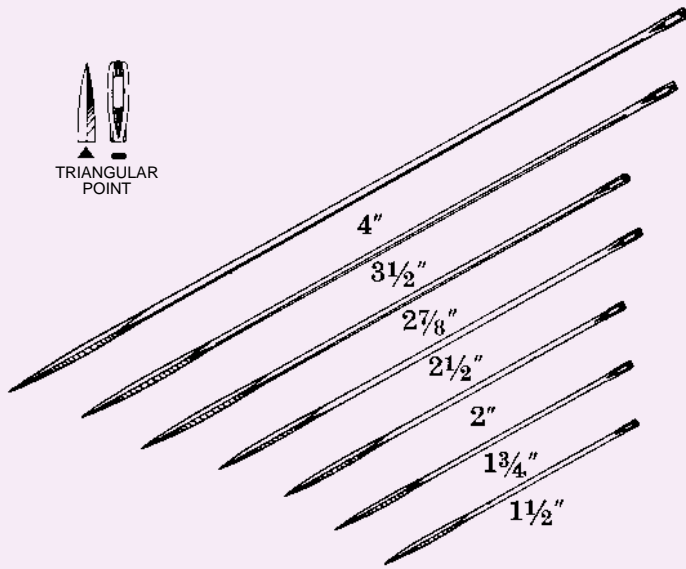
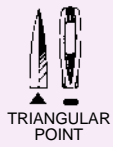

**KING 3/8 circle**

1841

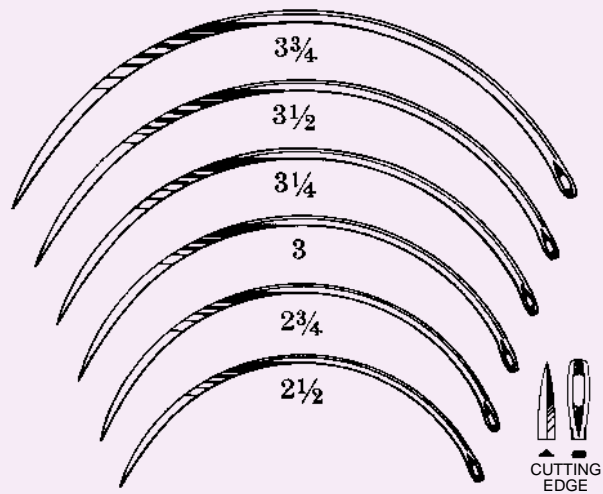

**KIDNEY**

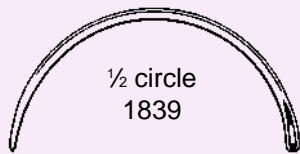
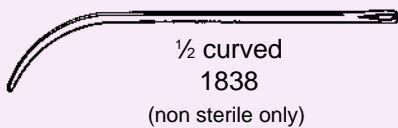

**LANES CLEFT PALATE**

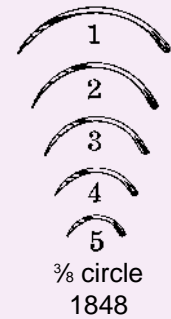
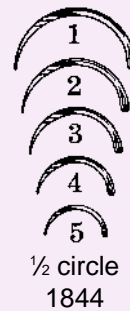

**LOOPUYT'S**

1846  
(non sterile only)

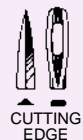
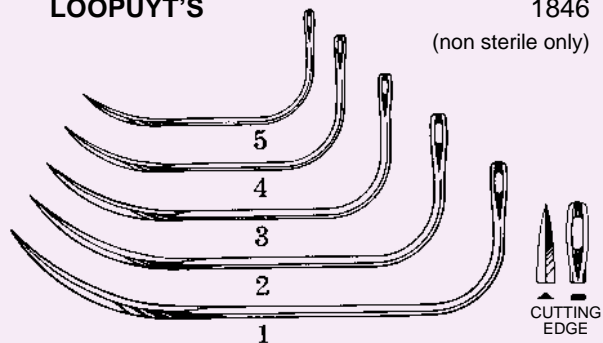

# SURGICAL NEEDLES

**MARTIN UTERINE** ½ circle  
(heavy gauge)

1860

(also used for orthopedics)

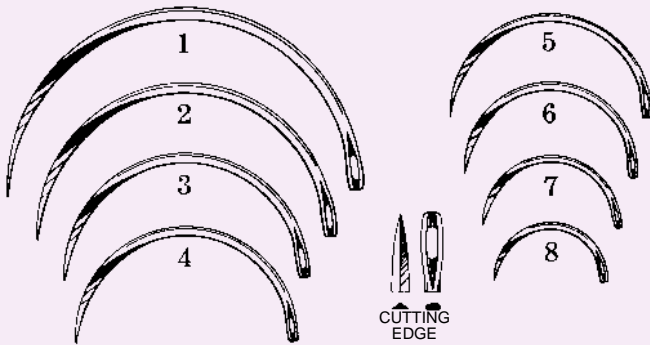

**MAYO INTESTINAL** straight

1828

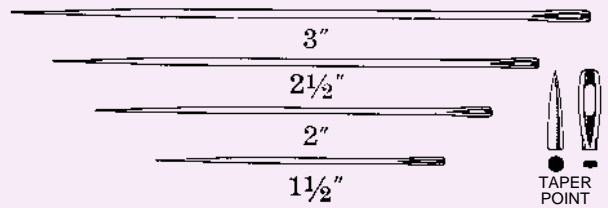

**MAYO** ½ circle

1824

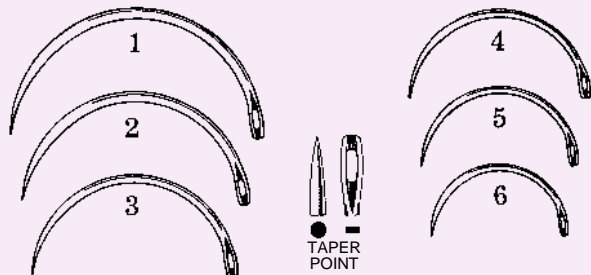

**McGOWAN** ½ circle  
(heavy gauge)

1859

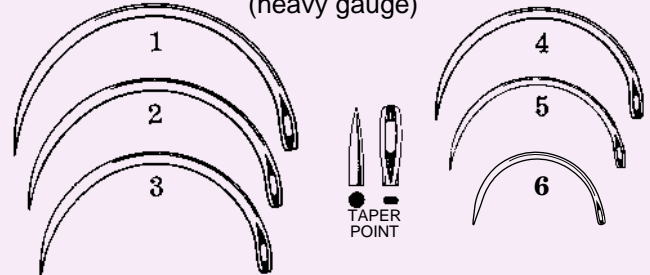

**MAYO INTESTINAL** ½ circle

1823

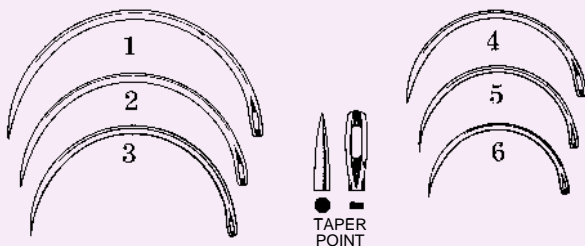

**MURPHY INTESTINAL** ½ circle

1825

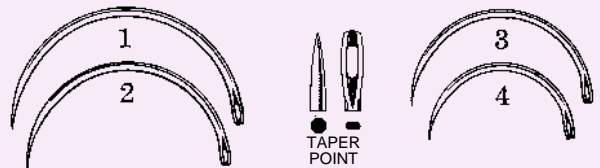

**MAYO INTESTINAL** ¾ circle

1837

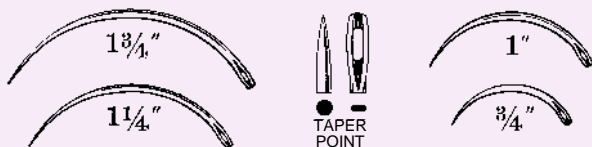

**ORTHOPEDIC**

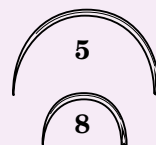

⅞ circle  
1869



⅞ circle  
1870

All needles are shown full scale in this catalog.

**REGULAR SURGEON'S 1/2 curved**  
(non-sterile only)



1821

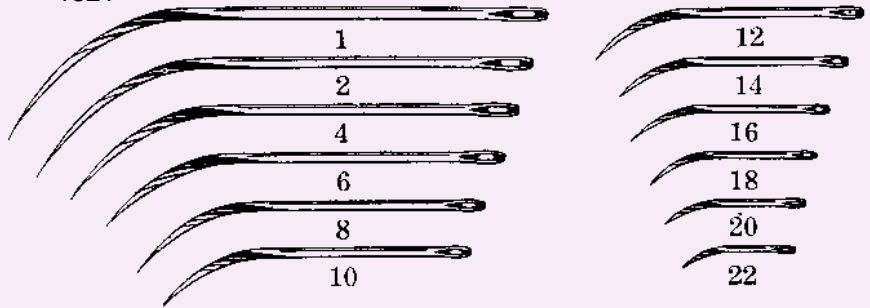

**REGULAR SURGEON'S 3/8 circle**

1822

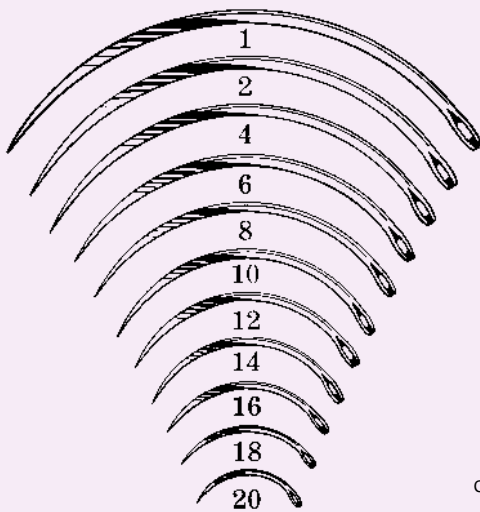

**TONSIL, DAVIS**



3/8 circle  
1845



1/2 circle  
1849

**TROCAR 1/2 circle**

1826

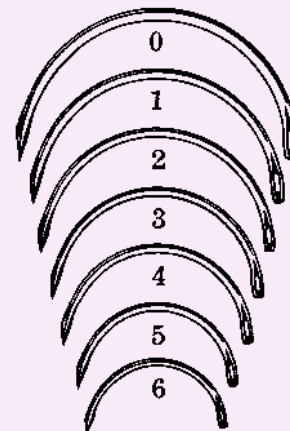

**REGULAR SURGEON'S 1/2 circle**  
(light gauge)

1834

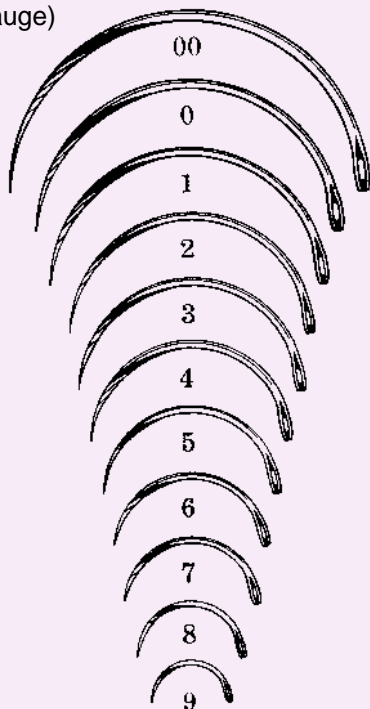

**TROCAR 3/8 circle**

1836

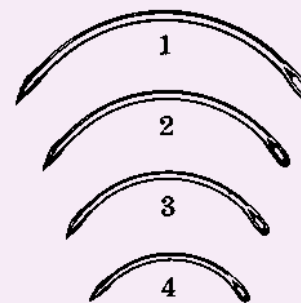

½ curved  
(non-sterile only)

1821

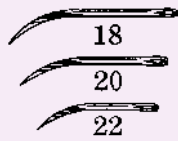

¾ circle

1822

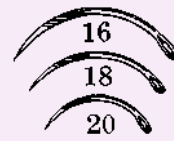

½ circle

1832

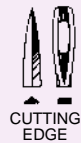
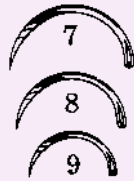

½ circle

1834

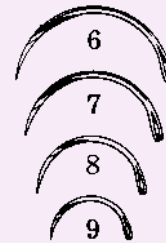

½ circle

1844



¾ circle

1848

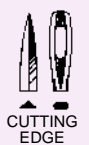
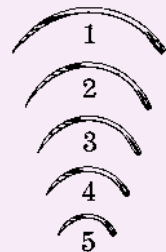

Post Mortem and Veterinary needles are available non-sterile only

All needles are shown full scale

## DOUBLE CURVED POST MORTEM

1819

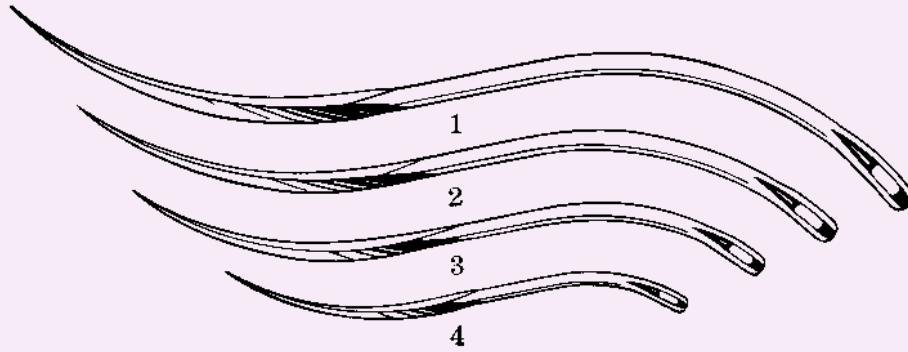

CUTTING  
EDGE

## HALF CURVED VETERINARY

1820

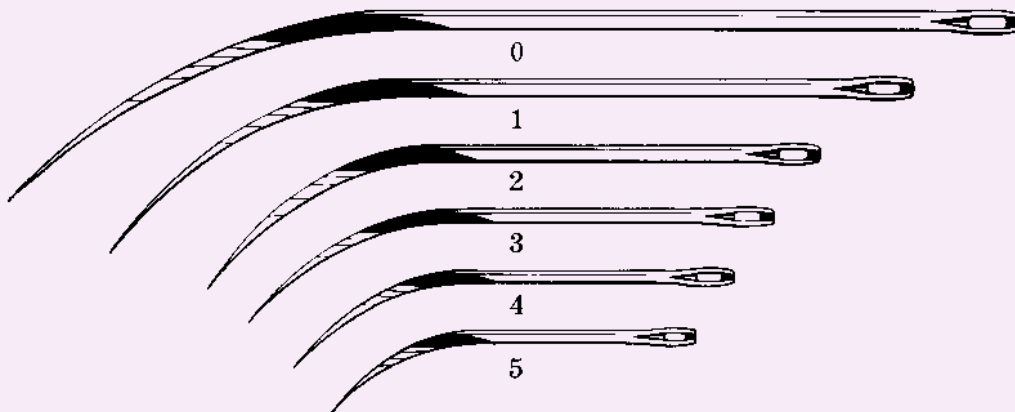

CUTTING  
EDGE

## CRUCIATE REPAIR "J" CURVED

1816

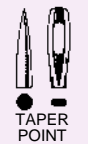
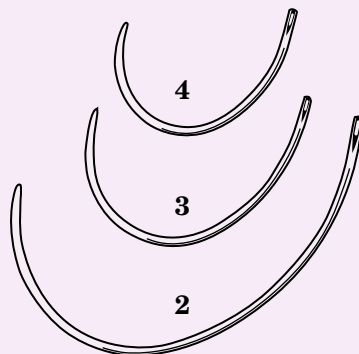

TAPER  
POINT

**VETERINARY straight**

1817

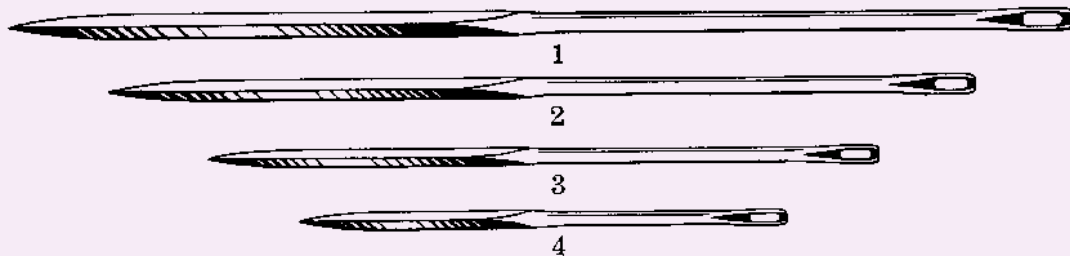

**VETERINARY 3/8 circle**

1818

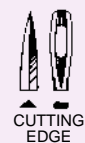
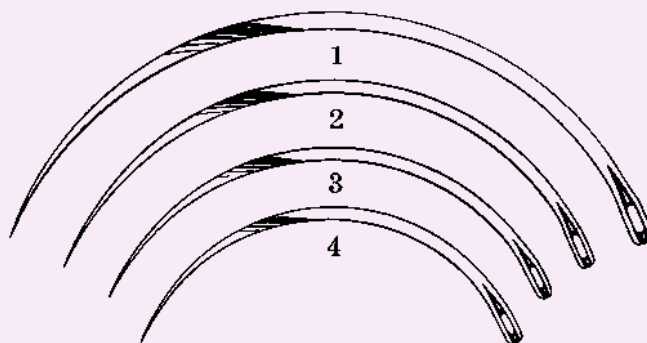

**FISTULA 1/2 circle**

1832

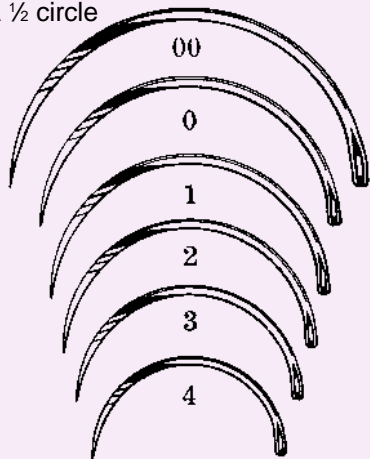

**REGULAR SURGEON'S 3/8 circle**

1822

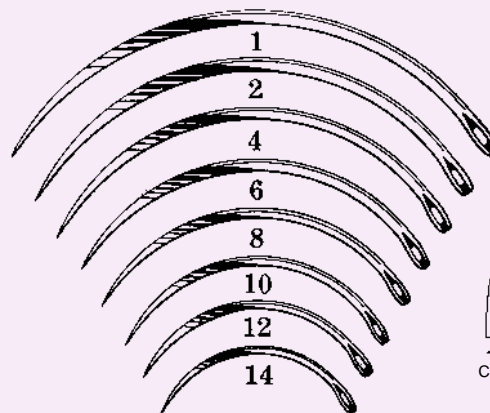

**VETERINARY half curved**

1821

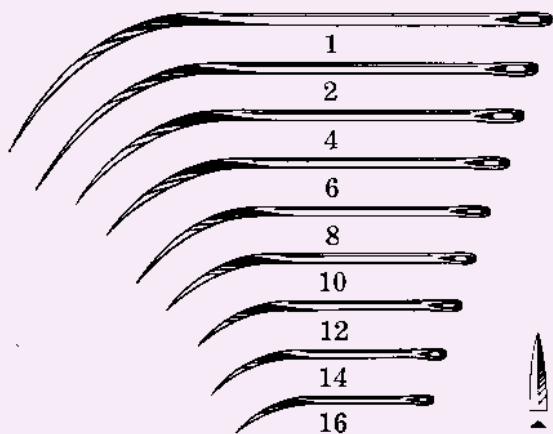

**LOOPUYT'S**

1846

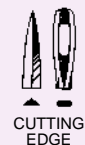
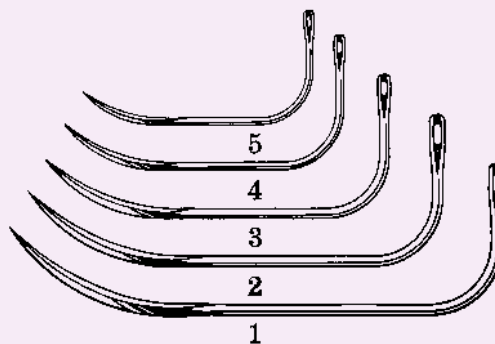

# ANCHOR STERILE DISPOSABLE CONVERSION TABLE



This table is intended for use as a guide in converting from other manufacturer's needle code numbers to ANCHOR equivalencies.

There could be instances when an exact conversion on a specific needle is not possible. In these instances, ANCHOR will provide comparable needle styles and let you decide your preference. ANCHOR also has the capability of duplicating virtually all special needles.

For the most accurate conversion, it is recommended that product samples be forwarded.

ANCHOR	RICHARD-ALLAN	HMS - TORRINGTON	ANCHOR	RICHARD-ALLAN	HMS - TORRINGTON	ANCHOR	RICHARD-ALLAN	HMS - TORRINGTON
1821-1	X	X	1831-1	2123-1	709-1	1843-1½	2147-4	721-1½
1821-2	X	X	1831-2	2123-2	709-2	1843-1¾	2147-3	721-1¾
1821-4	X	X	1831-3	2123-3	709-3	1843-2¼	2147-1	721-2¼
1821-6	X	X	1831-4	2123-4	709-4	1843-2¾	X	721-2¾
1821-8	X	X	1832-00	X	725-00	1844-1	2154-1;2157-1	729-1
1821-10	X	702-10	1832-0	2128-1	725-0	1844-2	2154-7/8;2157-2	729-2
1821-12	X	702-12	1832-1	2128-2	725-1	1844-3	2154-6/8;2157-3	729-3
1821-14	X	702-14	1832-2	2128-3	725-2	1844-4	2154-5/8;2157-4	729-4
1821-16	X	702-16	1832-3	2128-4	725-3	1844-5	2154-4/8,3/8	729-5
1821-18	X	702-18	1832-4	2432-4	725-4	1845	2195-0	732
1821-20	X	702-20	1832-5	2128-5;2432-5	725-5	1846-1	X	X
1821-22	X	X	1832-6	2128-6;2432-6	725-6	1846-2	X	X
1822-1	2090-1,2	700-1	1832-7	2432-7	725-7	1846-3	X	X
1822-2	2090-3	700-2	1832-8	2432-8	725-8	1846-4	X	X
1822-4	2090-4,5	700-4	1832-9	2432-9	725-9	1846-5	X	X
1822-6	2090-6,7	700-6	1833-1	2125-1;2500-0	716-1	1847	X	733
1822-8	2090-8,9,10	700-8	1833-2	2092-1;2125-2	716-2	1848-1	2153-1;2158-1	730-1
1822-10	2090-11,12	700-10	1833-3	2092-2;2125-3	716-3	1848-2	2153-7/8;6/8;2158-2	730-2
1822-12	2090-13,14	700-12	1833-4	2092-3;2125-4	716-4	1848-3	2153-5/8;2158-4	730-3
1822-14	2090-15,16	700-14	1834-00	2091-2,2091-3;2127-1	X	1848-4	2153-4/8	730-4
1822-16	2090-17,18,19,20	700-16	1834-0	2091-5	701-0	1848-5	2153-3/8	730-5
1822-18	2090-22,24	700-18	1834-1	2091-6,7;2127-2	701-1	1849	X	731
1822-20	2090-26,28,30	700-20	1834-2	2091-8;2127-3	701-2	1850-1	2150-5	703-1
1823-1	2151-1	705-1	1834-3	2091-9	701-3	1850-2	2150-4	703-2
1823-2	2151-2	705-2	1834-4	2091-10,11,12;2127-4,5	701-4	1850-3	X	703-3
1823-3	2151-3	705-3	1834-5	2091-13,14	701-5	1850-4	2150-3	703-4
1823-4	2151-4	705-4	1834-6	2091-15,16;2127-6	701-6	1850-5	2150-2	703-5
1823-5	2151-5	705-5	1834-7	2091-17,18;2127-7	701-7	1850-6	2150-1	703-6
1823-6	2151-6	705-6	1834-8	2091-19,20,22;2127-8	701-8	1851-1	X	737-1
1824-1	2167-0	707-1	1834-9	2091-26,28,30	701-9	1851-2	X	737-2
1824-2	2167-1;2222-1	707-2	1835-1	X	717-1	1851-3	X	737-3
1824-3	2167-2,3;2222-2	707-3	1835-2	X	717-2	1851-4	X	737-4
1824-4	2167-3,5;2222-3	707-4	1835-3	2168-1	717-3	1852-1½	X	X
1824-5	2167-4;2222-4	707-5	1835-4	2168-2,3	717-4	1852-2	X	719-2
1824-6	2167-5;2222-5	707-6	1835-5	2168-4	717-5	1852-2½	X	719-2½
1825-1	X	718-1	1835-6	X	717-6	1852-3	X	719-3
1825-2	2159-1;2181-1	718-2	1836-1	2169-1,2	710-1	1853	X	X
1825-3	2140-1,2;2159-2,3;2181-2	718-3	1836-2	2169-3	710-2	1854-2½	2200-2½	X
1825-4	2140-4;2181-3,4	718-4	1836-3	2169-4,5	710-3	1854-2¾	2200-2¾	X
1826-0	X	X	1836-4	2169-6	710-4	1854-2	2200-2	X
1826-1	2170-1	726-1	1837-¾	X	727-¾	1857	X	X
1826-2	2170-2;2426-2	726-2	1837-1	X	727-1	1859-1	X	X
1826-3	X	726-3	1837-1¼	X	727-1¼	1859-2	X	X
1826-4	2170-3;2426-4;2701-0	726-4	1837-1½	X	727-1½	1859-3	X	X
1826-5	2170-4,5;2426-5	726-5	1838	X	715	1859-4	X	X
1826-6	2170-6;2426-6	726-6	1839	2050-0	711	1859-5	X	X
1827-1½	2134-10	708-1½	1840	X	712	1859-6	2167-6	X
1827-1¾	2134-9	708-1¾	1841-2½	X	713-2½	1860-1	2164-1	714-0
1827-2	2134-8	708-2	1841-2¾	X	X	1860-2	2164-2	714-2
1827-2¼	2134-6,7	708-2¼	1841-3	X	X	1860-3	2135-1;2164-3	714-3
1827-2½	2134-4,5	708-2½	1841-3¼	2145-3	X	1860-4	2135-2;2164-4	714-4
1827-3½	2134-2,3	708-3½	1841-3½	2145-3¼;2441-3.5	713-3½	1860-5	2135-3;2164-5	714-5
1827-4	2134-1	X	1841-3¾	2145-4,3¾	X	1860-6	2135-4	714-6
1828-1½	X	704-1½	1842-00	2095-1,2	720-0	1860-7	2164-6,7	714-7
1828-2	2146-3	704-2	1842-2	2095-3,4	720-2	1860-8	X	714-8
1828-2½	X	704-2½	1842-4	2095-5,6,7	720-4	1861-1	2129-1;2002-2;	734S-1
1828-3	2146-1,2	X	1842-6	2095-8	720-6	1861-2	2129-2;2002-3,4	734S-2
1829	X	728	1842-8	2095-9,10	720-8	1861-3	2129-3,4	734S-3
1830-1	2124-3,4	706-1	1842-10	2095-11,12	720-10			
1830-2	2124-5	706-2	1842-12	2095-13,14,15	720-12			
1830-3	2124-6	706-3	1842-14	2095-16,17,18	720-14			
1830-4	X	706-4	1842-16	2442-16;2706-16	720-16			
			1842-18	2442-18;2707-18	720-18			
			1842-20	2442-20	720-20			
			1842-22	2442-22	720-22			

# ANCHOR NON-STERILE REUSABLE CONVERSION TABLE



This table is intended for use as a guide in converting from other manufacturer's needle code numbers to ANCHOR equivalencies.

There could be instances when an exact conversion on a specific needle is not possible. In these instances, ANCHOR will provide comparable needle styles and let you decide your preference. ANCHOR also has the capability of duplicating virtually all special needles.

For the most accurate conversion, it is recommended that product samples be forwarded.

ANCHOR	CINCIN-NATI	MILTEX	S. JACK-SON	JORG-ENSEN	ANCHOR	CINCIN-NATI	MILTEX	S. JACK-SON	JORG-ENSEN	ANCHOR	CINCIN-NATI	MILTEX	S. JACK-SON	JORG-ENSEN
1816-2	X	X	X	X	1827-1 1/2	827-1 1/2	431-1 1/2	X	X	1842-00	X	X	E-50	X
1816-3	X	X	X	X	1827-1 3/4	827-1 3/4	431-1 3/4	E-54	X	1842-2	842-2	126-2	E-57	X
1816-4	X	X	X	X	1827-2	827-2	431-2	X	X	1842-4	842-4	126-4	E-56	X
1817-1	X	X	X	X	1827-2 1/2	827-2 1/2	431-2 1/2	E-14	X	1842-6	842-6	126-6	X	X
1817-2	817-2	X	X	X	1827-2 7/8	827-2 7/8	431-2 7/8	X	X	1842-8	842-8	126-8	E-11,24	X
1817-3	817-3	X	X	X	1827-3 1/2	827-3 1/2	431-3 1/2	E-55	X	1842-10	842-10	126-10	X	6037-10
1817-4	817-4	X	X	X	1827-4	827-4	431-4	X	X	1842-12	842-12	126-12	X	6037-11
1818-1	816-5	1281-1	X	X	1828-1 1/2	828-1 1/2	152-1 1/2	X	X	1842-14	842-14	126-14	E-3,10	6037-12
1818-2	816-4	1281-2,3	X	X	1828-2	828-2	152-2	X	X	1842-16	842-16	126-16	E-12	6037-14
1818-3	816-3	1281-4,5	X	X	1828-2 1/2	828-2 1/2	152-2 1/2	X	X	1842-18	842-18	126-18	X	6037-15
1818-4	X	1281-6	X	X	1828-3	828-3	152-3	X	X	1842-20	842-20	126-20	X	6037-16
1819-1	819-1	1295-2	E-69	X	1829	829	200	X	X	1842-22	842-22	126-22	X	X
1819-2	819-2	1295-4	E-70	X	1830-1	830-1	172-1	X	X	1843-1 1/2	843-1 1/2	122-1 1/2	X	X
1819-3	819-3	1295-5	E-71	X	1830-2	830-2	172-2	X	X	1843-1 3/4	843-1 3/4	122-1 3/4	X	X
1819-4	819-4	1295-7	E-72	X	1830-3	830-3	172-3	X	X	1843-2 1/4	843-2 1/4	122-2 1/4	X	X
1820-0	820-0	1291-1	E-66	X	1830-4	830-4	172-4	X	X	1843-2 3/4	843-2 3/4	122-2 3/4	X	X
1820-1	820-1	1291-3	E-67	X	1831-1	831-1	175-1	E-61	X	1844-1	844-1	156-1	X	7031-13
1820-2	820-2	1291-5	X	X	1831-2	831-2	175-2	X	X	1844-2	844-2	156-2	E-36	X
1820-3	820-3	1291-6	X	X	1831-3	831-3	175-3	X	X	1844-3	844-3	156-3	E-29	X
1820-4	X	X	X	X	1831-4	831-4	175-4	X	X	1844-4	844-4	156-4	X	X
1820-5	X	X	X	X	1832-00	832-00	450-2/0	E-48	X	1844-5	844-5	156-5	X	X
1821-1	821-1	141-1	E-68	X	1832-0	832-0	450-1/0	X	X	1845	845	440	X	X
1821-2	821-2	141-2	X	X	1832-1	832-1	450-1	X	X	1846-1	846-1	1274—1	E-63	X
1821-4	821-4	141-3	X	X	1832-2	832-2	450-2	X	X	1846-2	846-2	1274-2	X	X
1821-6	821-6	141-4	X	X	1832-3	832-3	450-3	E-20	X	1846-3	846-3	1274-3	E-64	X
1821-8	821-8	141-5	X	X	1832-4	832-4	450-4	E-19	X	1846-4	846-4	1274-4	X	X
1821-10	821-10	141-6	X	X	1832-5	832-5	450-5	X	X	1846-5	846-5	1274-5	E-65	X
1821-12	821-12	141-7	X	X	1832-6	832-6	450-6	E-39	X	1847	847	201	X	X
1821-14	821-14	141-8	X	X	1832-7	832-7	450-7	X	X	1848-1	848-1	155-1	E-62	X
1821-16	821-16	141-9	X	X	1832-8	832-8	450-8	X	X	1848-2	848-2	155-2	E-15	X
1821-18	821-18	141-10	X	X	1832-9	832-9	450-9	X	X	1848-3	848-3	155-3	X	X
1821-20	821-20	141-11	X	X	1833-1	833-1	176-1	E-33	X	1848-4	848-4	155-4	X	X
1821-22	821-22	141-12	X	X	1833-2	833-2	176-2	X	X	1848-5	848-5	155-5	X	X
1822-1	922-1	140-1	X	X	1833-3	833-3	176-3	E-53,58	X	1849	849	441	X	X
1822-2	922-2	140-2,3	X	7011-2	1833-4	833-4	176-4	X	X	1850-1	850-1	135-1	X	X
1822-4	922-4	140-4,5	X	7011-4	1834-00	934-00	192-1/0,1,2	E-49	7031-2	1850-2	850-2	135-2	X	X
1822-6	922-6	140-6,7	E-38	7011-6	1834-0	934-0	192-3,4,5	X	7031-4	1850-3	853-3	135-3	E-6	X
1822-8	922-8	140-8,9	E-37	X	1834-1	934-1	192-6	X	7031-6	1850-4	850-4	135-4	E-7	X
1822-10	922-10	140-10,11	E-34	7011-8	1834-2	934-2	192-7,8	E-46	X	1850-5	850-5	135-5	E-2,5	X
1822-12	922-12	140-12,13	X	7011-10	1834-3	934-3	192-9,10	X	7031-8	1850-6	850-6	135-6	E-1	X
1822-14	922-14	140-14,15	E-26	7011-12	1834-4	934-4	192-11	E-43	7031-9	1851-1	851-1	178-1	X	X
1822-16	922-16	140-16,17	E-16	7011-13	1834-5	934-5	192-12,13	E-31	7031-10	1851-2	851-2	178-2	X	X
1822-18	922-18	140-18,19	E-41	7011-14	1834-6	934-6	192-14,15	E-30	7031-11	1851-3	851-3	178-3	X	X
1822-20	922-20	140-20	X	7011-16	1834-7	934-7	192-16,17	E-17	7031-12	1851-4	851-4	178-4	X	X
1823-1	823-1	154-1	X	X	1834-8	934-8	192-18,19	E-18	7031-14	1852-1 1/2	X	1095-1 1/2	X	X
1823-2	823-2	154-2	X	X	1834-9	934-9	192-20	E-42	7031-16	1852-2	852-2	1095-2	X	X
1823-3	823-3	154-3	X	X	1835-1	835-1	210-1	X	X	1852-2 1/2	X	1095-2 1/2	X	X
1823-4	823-4	154-4	E-8	X	1835-2	835-2	210-2	X	X	1852-3	X	1095-3	X	X
1823-5	823-5	154-5	X	X	1835-3	835-3	210-3	E-21	X	1853	X	X	X	X
1823-6	823-6	154-6	X	X	1835-4	835-4	210-4	X	X	1854-2	X	X	X	X
1824-1	824-1	112-1	E-60	6037-6	1835-5	835-5	210-5	X	X	1854-2 1/4	X	X	X	X
1824-2	824-2	112-2	X	6037-8	1835-6	835-6	210-6	X	X	1854-2 1/2	854-2 1/2	X	X	X
1824-3	824-3	112-3	E-45	X	1836-1	836-1	114-1	X	X	1857	857	177	X	X
1824-4	824-4	112-4	X	X	1836-2	836-2	114-2	X	X	1859-1	859-1	120-1	X	X
1824-5	824-5	112-5	E-44	X	1836-3	836-3	114-3	E-27	X	1859-2	859-2	120-2	E-47	X
1824-6	824-6	112-6	X	X	1836-4	836-4	114-4	X	X	1859-3	859-3	120-3	X	X
1825-1	825-1	179-1	X	X	1837-3/4	837-3/4	153-3/4	X	X	1859-4	859-4	120-4	X	X
1825-2	825-2	179-2	E-23	X	1837-1	837-1	153-1	X	X	1859-5	X	X	X	X
1825-3	825-3	179-3	E-22	X	1837-1 1/4	837-1 1/4	153-1 1/4	E-25	6017-11	1859-6	X	X	X	X
1825-4	825-4	179-4	E-4,13	X	1837-1 3/4	837-1 3/4	153-1 3/4	X	X	1860-1	860-1	117-1	X	X
1826-0	826-0	119-1/0	X	X	1838	X	435	X	X	1860-2	860-2	117-2	X	X
1826-1	826-1	119-1	X	X	1839	839	436	X	X	1860-3	860-3	117-3	E-59	X
1826-2	826-2	119-2	X	X	1840	840	434	X	X	1860-4	860-4	117-4	X	X
1826-3	826-3	119-3	X	X	1841-2 1/2	841-2 1/2	195-2 1/2	E-51	X	1860-5	860-5	117-5	X	X
1826-4	826-4	119-4	X	X	1841-2 3/4	841-2 3/4	195-2 3/4	X	X	1860-6	860-6	117-6	X	X
1826-5	826-5	119-5	X	X	1841-3	841-3	195-3	E-28	X	1860-7	860-7	117-7	E-40	X
1826-6	826-6	119.6	X	X	1841-3 1/4	841-3 1/4	195-3 1/4	X	X	1860-8	860-8	117-8	X	X
					1841-3 1/2	841-3 1/2	195-3 1/2	X	X	1861-1	871-1	116-1	X	X
					1841-3 3/4	841-3 3/4	195-3 3/4	E-52	X	1861-2	871-2	116-2	X	X
										1861-3	871-3	116-3	E-9	X



- Stronger brake prevents overspin and suture tangles.
- Cassette fits any cassette rack.
- Safety cap prevents cap loss and contamination.
- Anchor Chromic Gut is superior in quality.
- Polymid™ is a new name for the same, superb, coated white nylon.
- Manufactured in the U.S.A.

## Veterinary Sterile Suture Cassettes

### *Polymid™*

Order Code	Size	Length
SE-C-40	4/0	100 M
SE-C-30	3/0	100 M
SE-C-20	2/0	100 M
SE-C-10	1/0	75 M
SE-C-01	1	75 M
SE-C-02	2	50 M
SE-C-03	3	50 M
SE-C-04	4	25 M
SE-C-08	8	25 M

### *Chromic Gut*

Order Code	Size	Length
CG-C-40	4/0	50 M
CG-C-30	3/0	50 M
CG-C-20	2/0	50 M
CG-C-10	1/0	50 M
CG-C-01	1	50 M
CG-C-02	2	50 M
CG-C-03	3	50 M
CG-C-04	4	25 M



**anchor**

ANCHOR PRODUCTS COMPANY  
52 Official Rd. Addison, IL 60101  
Phone 630/543-9124 800/323-5134  
FAX 630/543-9131